

**BAXIROCA**

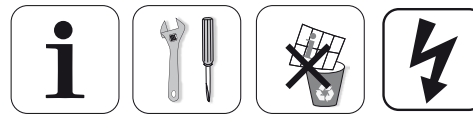

**SERVOMOTOR SM 81**

**BAXIROCA**



SERVOMOTOR SM 81

CE  
 LVD 2006/95/EC  
 EMC/2004/108/EC  
 RoHS 2002/95/EEC

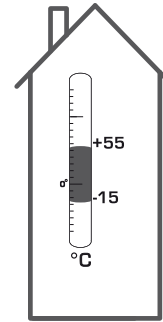

SERVOMOTOR SM 81



VÁLVULAS 3 VÍAS PLATINA  
 FLANGED MIXING VALVES  
 VÁLVULAS 3 VÍAS FLANGEADAS

1

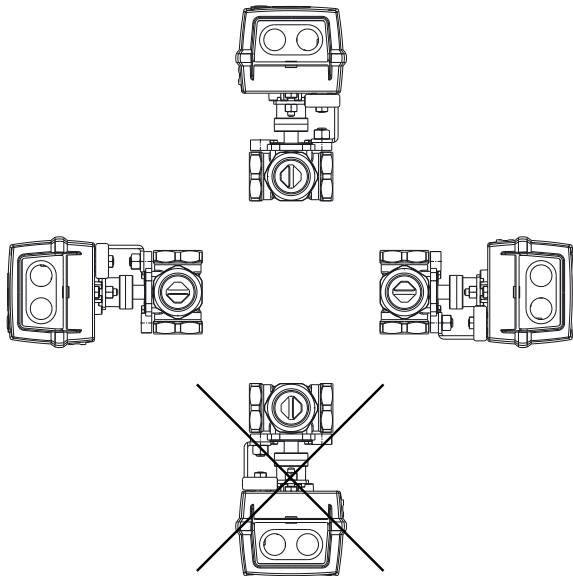

2



ADAPTADOR SM 81  
 ADAPTER KIT SM 81



VÁLVULAS 3 VÍAS PLATINA  
 FLANGED MIXING VALVES  
 VÁLVULAS 3 VÍAS FLANGEADAS

3

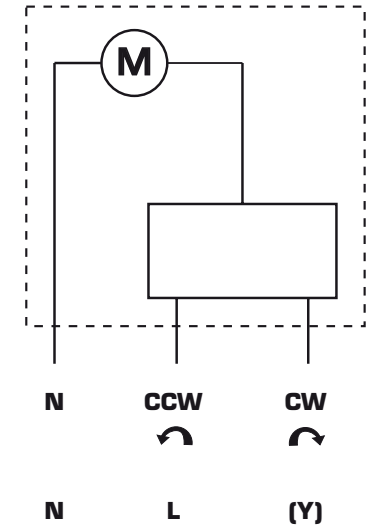

**BAXIROCA**

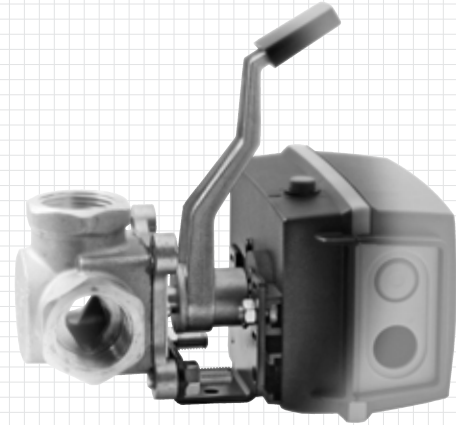

**ADAPTADOR SM 81  
ADAPTER KIT SM 81**

**BAXIROCA**



SERVOMOTOR SM 81



VÁLVULAS 3 VÍAS PLATINA  
FLANGED MIXING VALVES  
VÁLVULAS 3 VÍAS FLANGEADAS

**1**

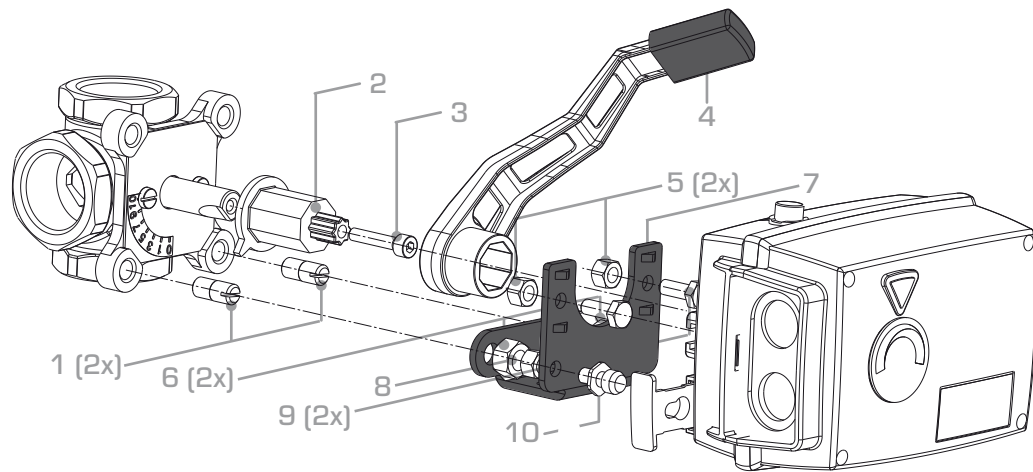

**2**

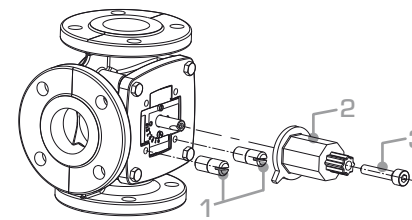

**3**

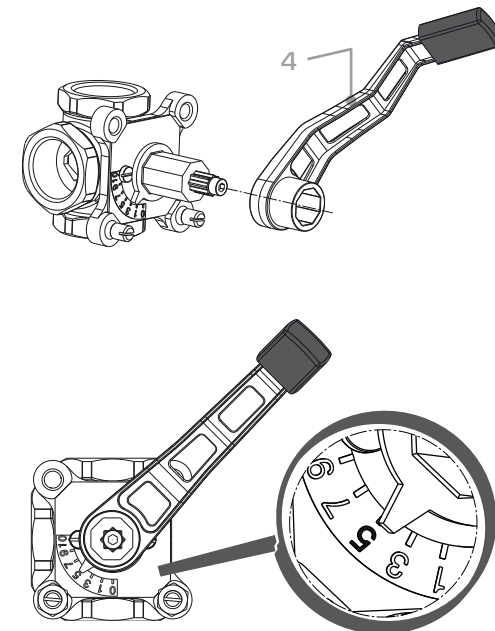

**BAXIROCA**

**VÁLVULAS 3 VÍAS PLATINA  
FLANGED MIXING VALVES  
VÁLVULAS 3 VÍAS FLANGEADAS**

2 1/2" - 3" - 4"

**BAXIROCA**



CE  
PED 97/23/EC

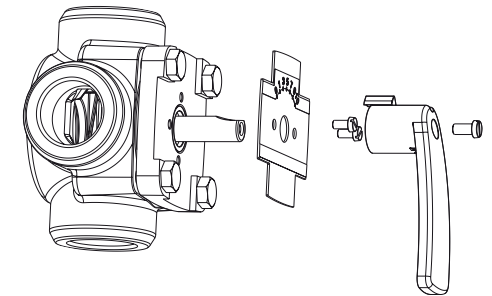
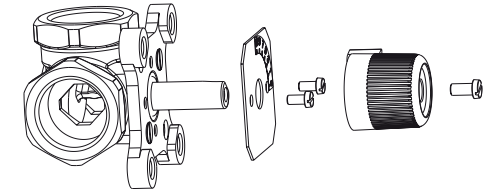
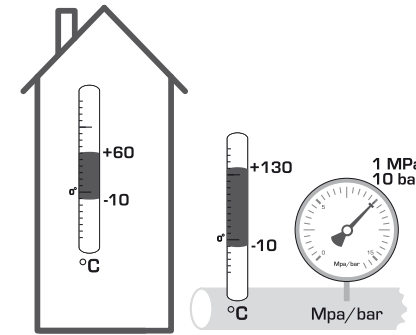

**1a**

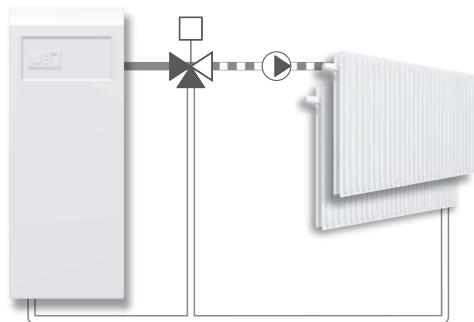
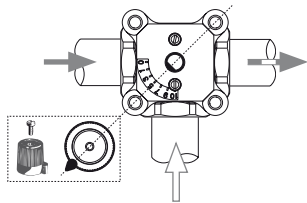

**1b**

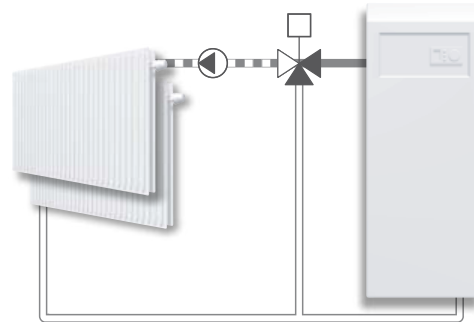
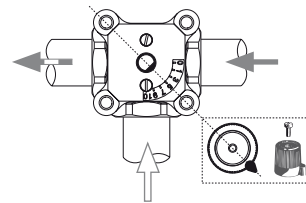

**2a**

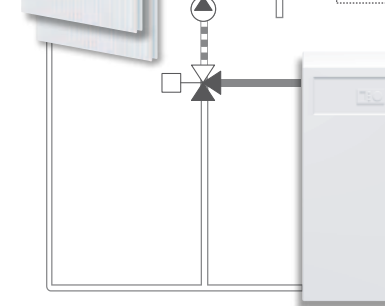
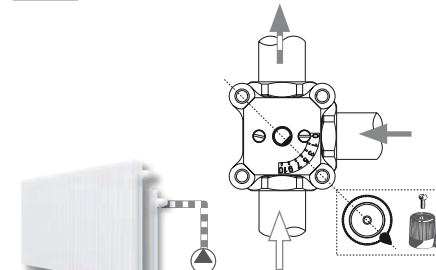

**2b**

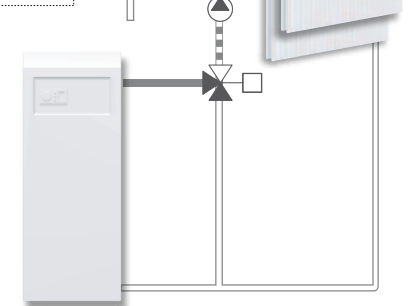
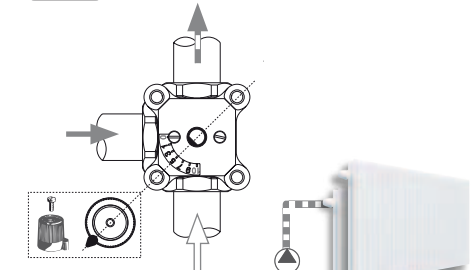

3a

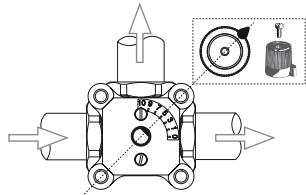
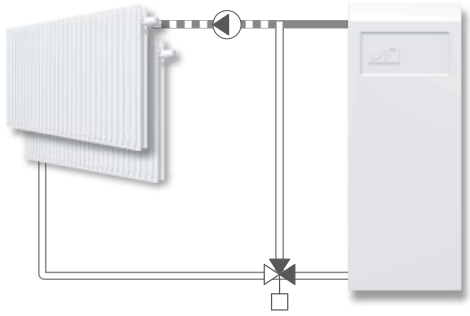

3b

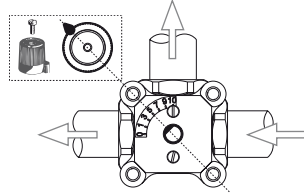
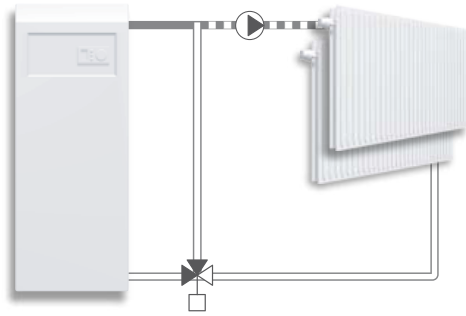
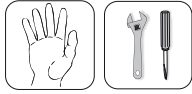

4a

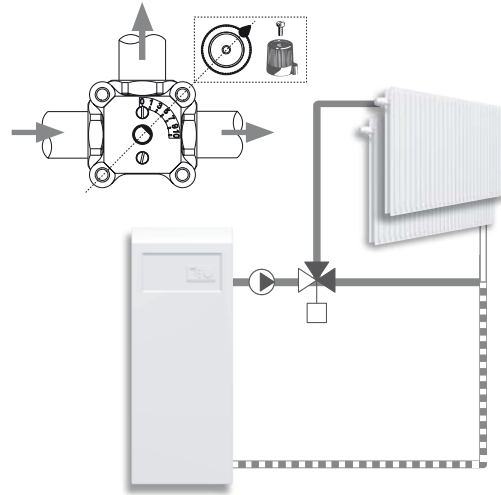

4b

